

# Analog Devices Welcomes Hittite Microwave Corporation

NO CONTENT ON THE ATTACHED DOCUMENT HAS CHANGED



**THIS PAGE INTENTIONALLY LEFT BLANK**

## 0.5dB LSB GaAs MMIC 6-BIT DIGITAL ATTENUATOR, DC - 3 GHz

### Typical Applications

The HMC424G16 is ideal for:

- Telecom Infrastructure
- Military Radios, Radar & ECM
- Space Applications
- Test Instrumentation

### Features

- 0.5 dB LSB Steps to 31.5 dB
- Single Control Line Per Bit
- $\pm 0.5$  to  $\pm 0.8$  dB Typical Bit Error
- 16 Lead Hermetic SMT Package

### Functional Diagram

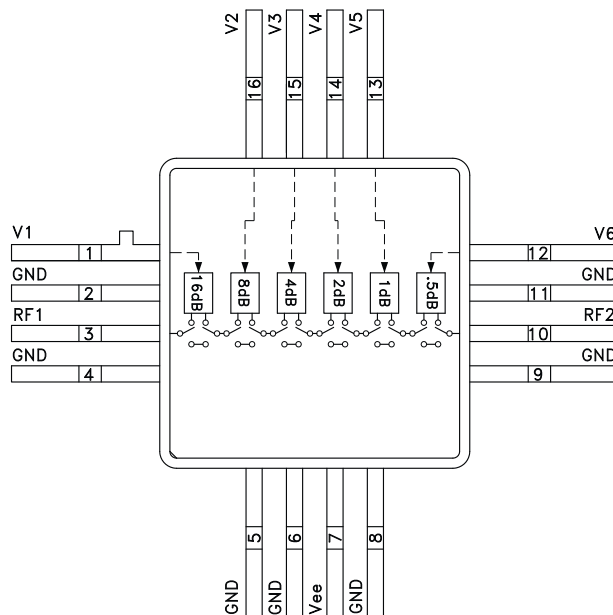

### General Description

The HMC424G16 is a broadband 6-bit GaAs IC digital attenuator in a 16 lead glass/metal (hermetic) surface mount package. Covering DC to 3 GHz, the insertion loss is less than 3 dB typical. The attenuator bit values are 0.5 (LSB), 1, 2, 4, 8, and 16 dB for a total attenuation of 31.5 dB. Attenuation accuracy is excellent at  $\pm 0.5$  dB typical step error with an IIP3 of +32 dBm. Six control voltage inputs, toggled between 0 and -5V, are used to select each attenuation state at less than 70  $\mu$ A each. A single Vee bias of -5V allows operation at frequencies down to DC.

### Electrical Specifications, $T_A = +25^\circ \text{C}$ , With Vee = -5V & Vctl = 0/-5V

Parameter	Frequency (GHz)	Min.	Typ.	Max.	Units
Insertion Loss	DC - 3 GHz		3.0	3.6	dB
Attenuation Range	DC - 3 GHz		31.5		dB
Return Loss (RF1 & RF2, All Atten. States)	DC - 3 GHz		12		dB
Attenuation Accuracy: (Referenced to Insertion Loss)	All States	DC - 2.0 GHz	$\pm 0.4 + 4\%$ of Atten. Setting Max		dB
	All States	2.0 - 3.0 GHz	$\pm 0.5 + 5\%$ of Atten. Setting Max		dB
Input Power for 0.1 dB Compression	1.0 - 3.0 GHz		22		dBm
Input Third Order Intercept Point (Two-Tone Input Power= 0 dBm Each Tone)	1.0 - 3.0 GHz	REF State	46		dBm
		All Other States	32		dBm
Switching Characteristics	DC - 3 GHz				
tRISE, tFALL (10/90% RF)			30		ns
tON/tOFF (50% CTL to 10/90% RF)			50		ns

## 0.5dB LSB GaAs MMIC 6-BIT DIGITAL ATTENUATOR, DC - 3 GHz

**Insertion Loss**

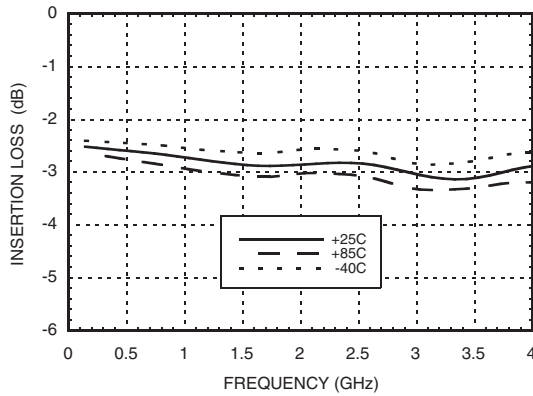

**Return Loss RF1, RF2**  
(Only Major States are Shown)

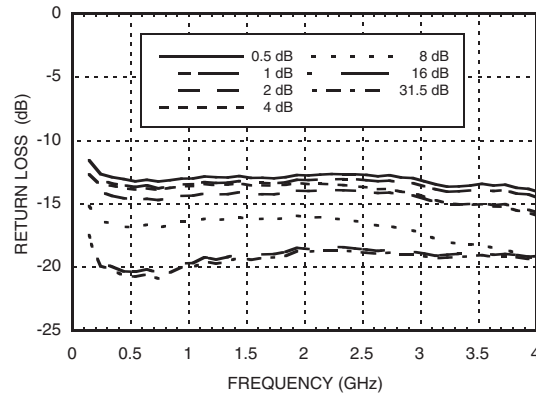

**Normalized Attenuation**  
(Only Major States are Shown)

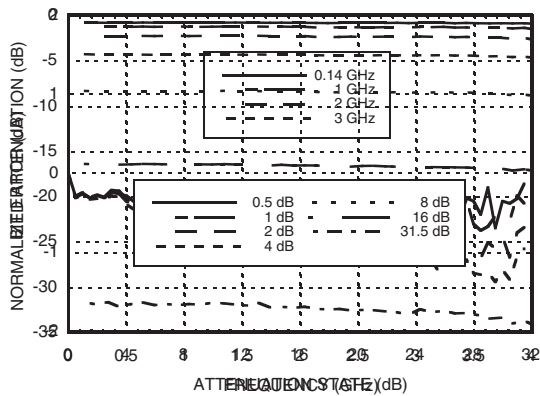

**Bit Error vs. Attenuation State**

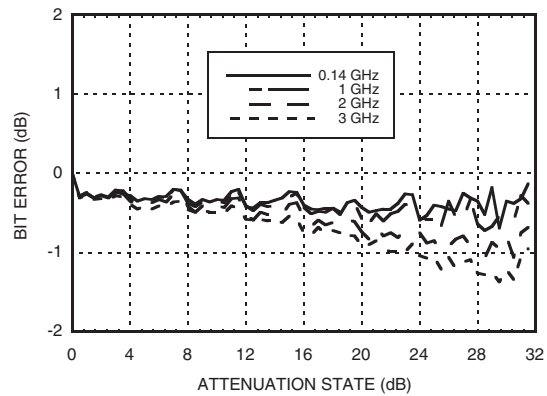

**Bit Error vs. Frequency**  
(Only Major States are Shown)

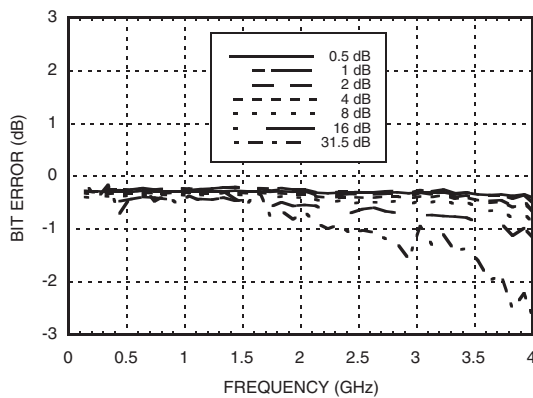

**Relative Phase vs. Frequency**  
(Only Major States are Shown)

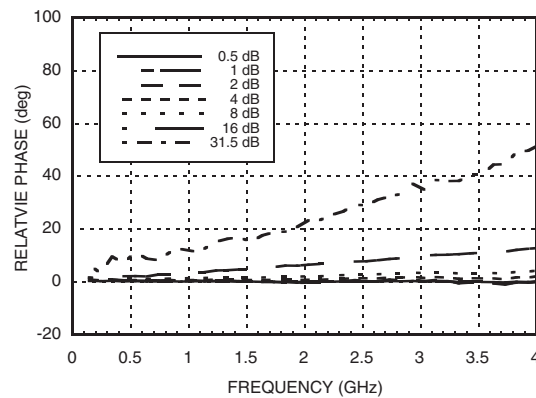

## 0.5dB LSB GaAs MMIC 6-BIT DIGITAL ATTENUATOR, DC - 3 GHz

5

ATTENUATORS - DIGITAL - SMT

### Worst Case Step Error Between Successive Attenuation States

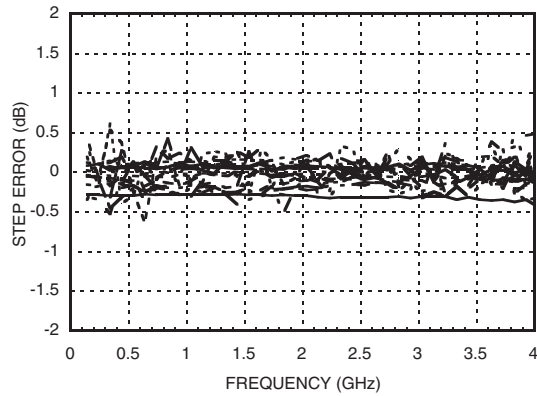

### Bias Voltage & Current

Vee Range= -5 Vdc ± 10%		
Vee (VDC)	Iee (Typ.) (mA)	Iee (Max.) (mA)
-5	2	5

### Control Voltage

State	Bias Condition
Low	0 to -3V @ 35 µA Typ.
High	-5 to -4.2V @ 5 µA Typ.

### Truth Table

Control Voltage Input						Attenuation State RF1 - RF2
V1 16 dB	V2 8 dB	V3 4 dB	V4 2 dB	V5 1 dB	V6 0.5 dB	
Low	Low	Low	Low	Low	Low	Reference I.L.
Low	Low	Low	Low	Low	High	0.5 dB
Low	Low	Low	Low	High	Low	1 dB
Low	Low	Low	High	Low	Low	2 dB
Low	Low	High	Low	Low	Low	4 dB
Low	High	Low	Low	Low	Low	8 dB
High	Low	Low	Low	Low	Low	16 dB
High	High	High	High	High	High	31.5 dB

Any Combination of the above states will provide an attenuation approximately equal to the sum of the bits selected.

**0.5dB LSB GaAs MMIC 6-BIT DIGITAL  
ATTENUATOR, DC - 3 GHz**

**Absolute Maximum Ratings**

Control Voltage (V1 to V6)	Vee - 0.5 Vdc
Bias Voltage (Vee)	-7 Vdc
Channel Temperature	150 °C
Thermal Resistance	330 °C/W
Storage Temperature	-65 to + 150 °C
Operating Temperature	-55 to +85 °C
RF Input Power (0.5 - 13.0 GHz)	+25 dBm



**ELECTROSTATIC SENSITIVE DEVICE  
OBSERVE HANDLING PRECAUTIONS**

**Outline Drawing**

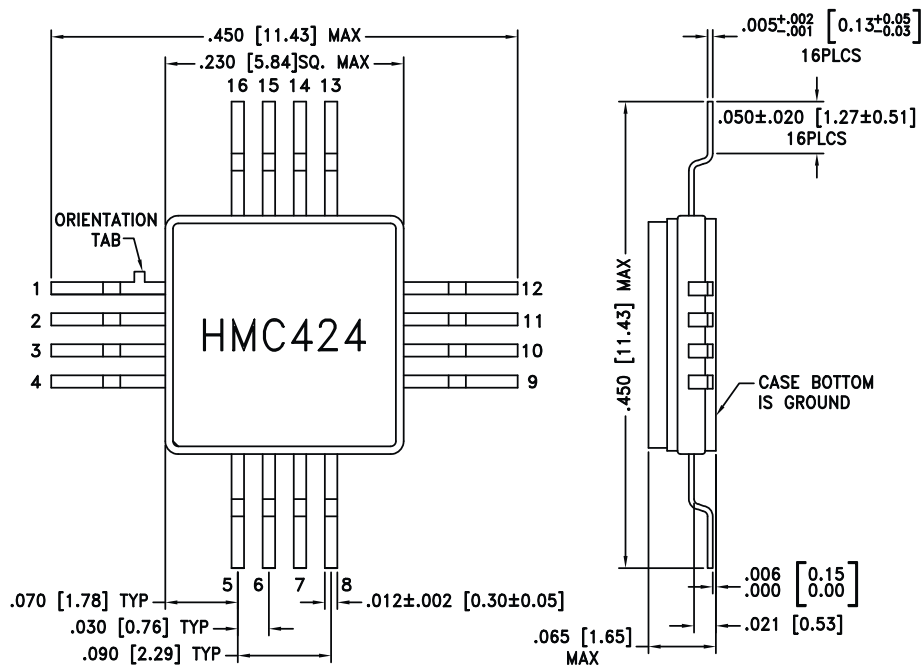

**NOTES:**



1. PACKAGE MATERIAL: ALUMINA LOADED BOROSILICATE GLASS.
2. LEADS, BASE, COVER MATEIRAL: KOVARTM (#7052 CORNING).
3. PLATING: ELECTROLYTIC GOLD 50 MICROINCHES MIN., OVER ELECTROLYTIC NICKEL 75 MICROINCHES MIN.
4. ALL DIMENSIONS ARE IN INCHES [MILLIMETERS].
5. TOLERANCES: 0.005 [.013] UNLESS OTHERWISE SPECIFIED.
6. CHARACTERS TO BE HELVETICA MEDIUM .030 HIGH, BLACK INK, LOCATED APPROX. AS SHOWN.
7. ALL GROUND LEADS AND GROUND PADDLE MUST BE SOLDERED TO PCB RF GROUND.

**0.5dB LSB GaAs MMIC 6-BIT DIGITAL  
ATTENUATOR, DC - 3 GHz**

5

ATTENUATORS - DIGITAL - SMT

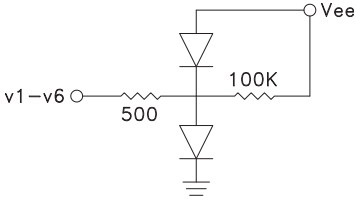
**Pin Descriptions**

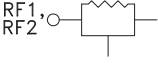
Pin Number	Function	Description	Interface Schematic
1, 12-16	V1 - V6	See truth table and control voltage table.	
2, 4-6, 8, 9, 11	GND	Package bottom must also be connected to RF/DC ground.	
3, 10	RF1, RF2	These pins are DC coupled and matched to 50 Ohm. Blocking capacitors are required if RF line is not equal to 0V.	
7	Vee	Supply Voltage -5V ±10%	

**Suggested Driver Circuit**

(One Circuit Required Per Bit Control Input)

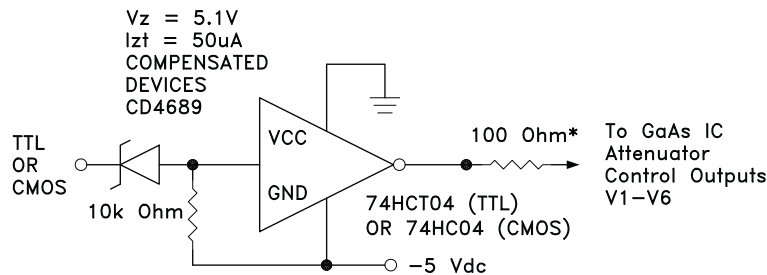

Simple driver using inexpensive standard logic ICs provides fast switching using minimum DC current. \* Recommended value to suppress unwanted RF signals at V1 - V6 control lines.

**Evaluation PCB**

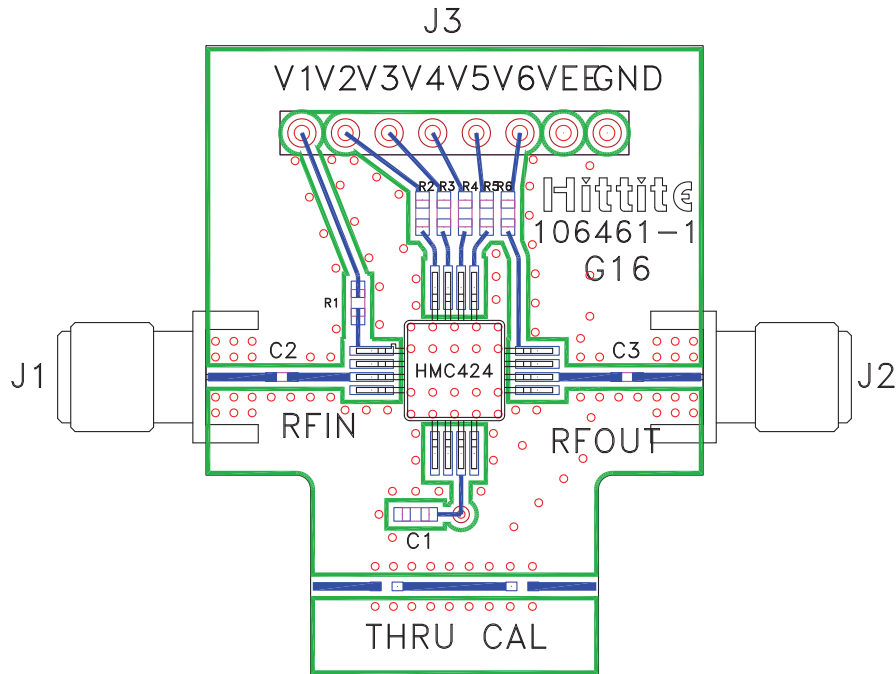

**List of Materials for Evaluation PCB 106566 [1]**

Item	Description
J1 - J2	PCB Mount SMA Connector
J3	8 Pin DC Connector
C1	0.01 $\mu$ F Capacitor, 0603 Pkg.
C2, C3	100 pF Capacitor, 0402 Pkg.
R1 - R6	100 Ohm Resistor, 0603 Pkg.
U1	HMC424G16 Digital Attenuator
PCB [2]	106461 Evaluation PCB

[1] Reference this number when ordering complete evaluation PCB

[2] Circuit Board Material: Rogers 4350

The circuit board used in the final application should use RF circuit design techniques. Signal lines should have 50 ohm impedance while the package ground leads and package bottom should be connected directly to the ground plane similar to that shown. A sufficient number of via holes should be used to connect the top and bottom ground planes. The evaluation circuit board shown is available from Hittite upon request.